

# 4-Digit Multi Panel Meters



## MT4W Series PRODUCT MANUAL

For your safety, read and follow the considerations written in the instruction manual, other manuals and Autonics website.

The specifications, dimensions, etc. are subject to change without notice for product improvement. Some models may be discontinued without notice.

### Features

- Various input / output options (by model)
  - Input options: DC voltage, DC current, AC voltage, AC current
  - Output options: RS485 communication output, low speed serial output, BCD dynamic output, transmission output (DC 4 - 20 mA), NPN / PNP open collector output, relay contact output (default option: indicator / no output)
- Maximum allowed input: 500 VDC $\overline{=}$ , DC 5 A, 500 VAC $\sim$ , AC 5 A
- Display range: -1999 to 9999
- High / low-limit display scale function
- AC frequency measurement (range: 0.1 to 9999 Hz)
- Various functions: peak display value monitoring, display cycle delay, zero-point adjustment, peak display value correction, PV transmission output (DC 4 - 20 mA) scale, etc.
- Power supply: 12 - 24 VDC $\overline{=}$ , 100 - 240 VAC $\sim$
- DIN W 72 × H 36 mm

### Safety Considerations

- Observe all 'Safety Considerations' for safe and proper operation to avoid hazards.
- $\triangle$  symbol indicates caution due to special circumstances in which hazards may occur.

**$\triangle$  Warning** Failure to follow instructions may result in serious injury or death.

- 01. Fail-safe device must be installed when using the unit with machinery that may cause serious injury or substantial economic loss. (e.g. nuclear power control, medical equipment, ships, vehicles, railways, aircraft, combustion apparatus, safety equipment, crime / disaster prevention devices, etc.)**  
Failure to follow this instruction may result in personal injury, economic loss or fire.
- 02. Do not use the unit in the place where flammable / explosive / corrosive gas, high humidity, direct sunlight, radiant heat, vibration, impact or salinity may be present.**  
Failure to follow this instruction may result in explosion or fire.
- 03. Install on a device panel to use.**  
Failure to follow this instruction may result in fire or electric shock.
- 04. Do not connect, repair, or inspect the unit while connected to a power source.**  
Failure to follow this instruction may result in fire or electric shock.
- 05. Check 'Connections' before wiring.**  
Failure to follow this instruction may result in fire.
- 06. Do not disassemble or modify the unit.**  
Failure to follow this instruction may result in fire or electric shock.

**$\triangle$  Caution** Failure to follow instructions may result in injury or product damage.

- 01. When connecting the power / measurement input and relay output, use AWG 24 (0.20 mm<sup>2</sup>) to AWG 15 (1.65 mm<sup>2</sup>) cable or over and tighten the terminal screw with a tightening torque of 0.98 to 1.18 N m. Use the wiring suitable for the load current capacity.**  
Failure to follow this instruction may result in fire or malfunction due to contact failure.
- 02. Use the unit within the rated specifications.**  
Failure to follow this instruction may result in fire or product damage.
- 03. Use a dry cloth to clean the unit, and do not use water or organic solvent.**  
Failure to follow this instruction may result in fire or electric shock.
- 04. Keep the product away from metal chip, dust, and wire residue which flow into the unit.**  
Failure to follow this instruction may result in fire or product damage.

### Cautions during Use

- Follow instructions in 'Cautions during Use'.  
Otherwise, it may cause unexpected accidents.
- Power supply should be insulated and limited voltage / current or Class 2, SELV power supply device.
- Install a power switch or circuit breaker in the easily accessible place for supplying or disconnecting the power.
- Use twisted pair wire for communication line.
- Keep away from high voltage lines or power lines to prevent inductive noise. In case installing power line and input signal line closely, use line filter or varistor at power line and shielded wire at input signal line.  
Do not use near the equipment which generates strong magnetic force or high frequency noise.

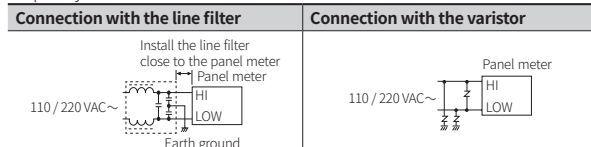

- This unit may be used in the following environments.
  - Indoors (in the environment condition rated in 'Specifications')
  - Altitude max. 2,000 m
  - Pollution degree 2
  - Installation category II

## Ordering Information

This is only for reference, the actual product does not support all combinations. For selecting the specified model, follow the Autonics website.

MT 4 W - ① - ② ③

### ① Input type

DV: DC voltage<sup>(01)</sup>  
DA: DC current  
AV: AC voltage<sup>(02)</sup>  
AA: AC current<sup>(02)</sup>

### ② Power supply

1: 12 - 24 VDC  $\pm$  10 %  
4: 100 - 240 VAC  $\pm$  10 % 50 / 60 Hz

### ③ Preset output + Sub output

	Preset output	Sub output
N	None (indicator)	
0	Relay	Transmission (DC 4 - 20 mA)
1	Relay	-
2	NPN open collector	BCD Dynamic
3	PNP open collector	BCD Dynamic
4	NPN open collector	Transmission (DC 4 - 20 mA)
5	PNP open collector	Transmission (DC 4 - 20 mA)
6	NPN open collector	Low speed serial
7	PNP open collector	Low speed serial
8	NPN open collector	RS485 Communication
9	PNP open collector	RS485 Communication

(01) To measure the current over DC 5 A, please select DV type because the shunt should be used.

(02) In case of selecting frequency display, no output will be provided even if it is output support model.

## Product Components

- Product
- Instruction manual
- Bracket  $\times$  2
- Unit sticker  $\times$  1

## Manual

For proper use of the product, refer to the manuals and be sure to follow the safety considerations in the manuals.

Download the manuals from the Autonics website.

## Software

Download the installation file and the manuals from the Autonics website.

### ■ DAQMaster

It is the comprehensive device management program for Autonics' products, providing parameter setting, monitoring and data management.

## Dimensions

Unit: mm, For the detailed drawings, follow the Autonics website.

### ■ Indicator / Relay preset output model

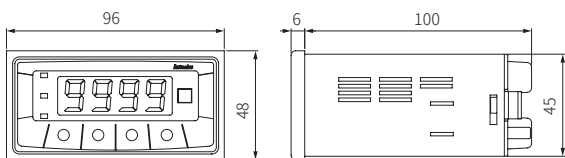

### ■ NPN / PNP open collector preset output model

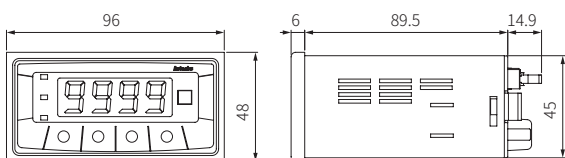

### ■ Bracket

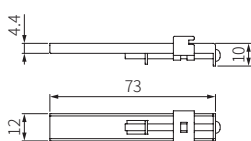

### ■ Panel cut-out

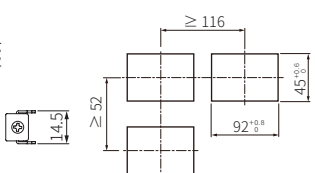

## Cautions during Wiring

Use the Copper-conductor wire with the temperature class 60 °C.

- Unit: mm, Use terminals of size specified below.
- Contact the manufacture for the socket and cable.

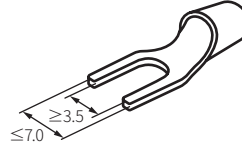

	Model
Hirose connector	HIF3BA-20PA-2.54DS
Hirose connector socket	HIF3BA-20D-2.54R

## Connections

### ■ Input

#### • DC voltage

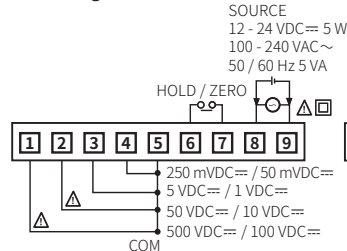

#### • DC current

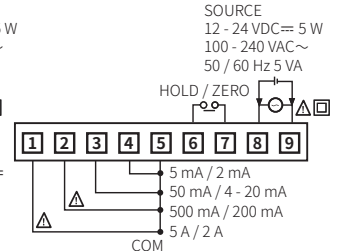

#### • AC voltage

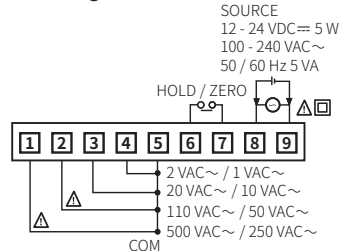

#### • AC current

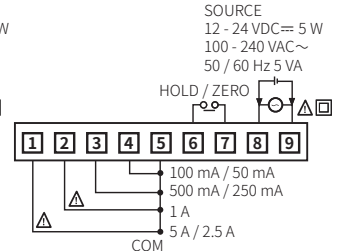

### ■ Output

#### • 0: Relay + Transmission (DC 4 - 20 mA)

Main OUT: Contact OUT: 250 VAC  $\sim$  3A 1a DC 4 - 20 mA resistive load Load 600  $\Omega$  Max.

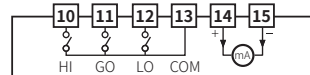

#### • 1: Relay

Main OUT: Contact OUT: 250 VAC  $\sim$  3A 1a resistive load

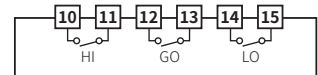

#### • 2: NPN open collector + BCD Dynamic

Main OUT: NPN open collector 12 - 24 VDC  $\pm$  Max. 50 mA

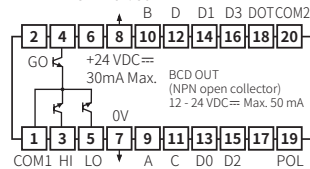

#### • 3: PNP open collector + BCD Dynamic

Main OUT: PNP open collector 12 - 24 VDC  $\pm$  Max. 50 mA

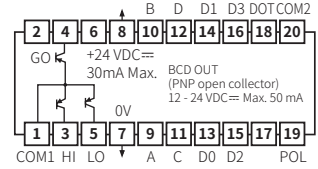

#### • 4: NPN open collector + Transmission (DC 4 - 20 mA)

Main OUT: NPN open collector 12 - 24 VDC  $\pm$  Max. 50 mA

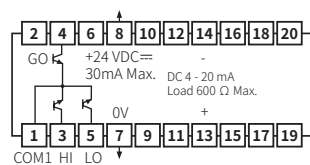

#### • 5: PNP open collector + Transmission (DC 4 - 20 mA)

Main OUT: PNP open collector 12 - 24 VDC  $\pm$  Max. 50 mA

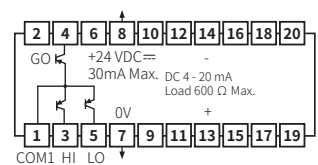

#### • 6: NPN open collector + Low speed serial

Main OUT: NPN open collector 12 - 24 VDC  $\pm$  Max. 50 mA

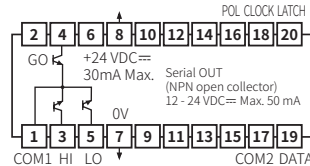

#### • 7: PNP open collector + Low speed serial

Main OUT: PNP open collector 12 - 24 VDC  $\pm$  Max. 50 mA

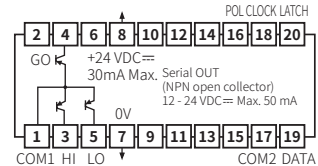

#### • 8: NPN open collector + RS485 Comm.

Main OUT: NPN open collector 12 - 24 VDC  $\pm$  Max. 50 mA

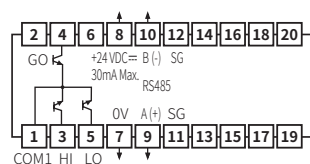



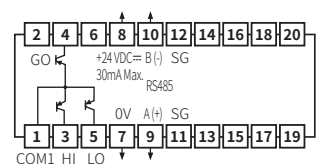

#### • 9: PNP open collector + RS485 Comm.

Main OUT: PNP open collector 12 - 24 VDC  $\pm$  Max. 50 mA



## Specifications

Model	MT4W-DV-□□	MT4W-DA-□□	MT4W-AV-□□	MT4W-AA-□□
Input type	DC voltage	DC current	AC voltage <sup>(1)</sup>	AC current <sup>(1)</sup>
Max. allowable input	110 % F.S. for each measured input range			
Display method	7-segment (red) LED (character height: 14.2 mm)			
Display accuracy	Dependent on the ambient temperature			
23 ± 5 °C	± 0.1 % F.S. rdg ± 2 digit	± 0.1 % F.S. rdg ± 2 digit <sup>(2)</sup>	± 0.3 % F.S. rdg ± 3 digit	± 0.3 % F.S. rdg ± 3 digit
-10 to 50 °C	± 0.5 % F.S. rdg ± 3 digit			
Max. display range	-1999 to 9999 (4 digit)			
A / D conversion method	ΣΔ (Sigma Delta) ADC			
Sampling cycle	50 ms	16.6 ms		
Unit weight (packaged)	≈ 211 g (≈ 326 g)			
Approval	CE     			

01) Available frequency display, Display accuracy (23 ± 5 °C): ± 0.1 % F.S. rdg ± 2 digit

02) 5 A terminal: ± 0.3 % F.S. rdg ± 3 digit

03) Except power supply 12 - 24 VDC ⇒ model

Preset output	None (indicator) / Relay / NPN open collector / PNP open collector output model
Relay	Contact capacity: 250 VAC ~ 3 A, 30 VDC ~ 3 A Contact composition: N.O (1a)
NPN / PNP open collector	Output capacity: ≤ 12 - 24 VDC ⇒ ± 2 VDC ⇒, 50 mA resistive load
Sub output	None (indicator) / BCD Dynamic / Transmission (DC 4 - 20 mA) / Low speed serial / RS485 Communication output model
BCD Dynamic / Low speed serial	NPN open collector output Output capacity: ≤ 12 - 24 VDC ⇒, 50 mA resistive load
Transmission (DC 4 - 20 mA)	Resolution: 1/12,000 (load resistance: ≤ 600 Ω) Response time: ≤ 450 ms
RS485 communication	Protocol: Modbus RTU

Model	MT4W-□□-1□	MT4W-□□-4□
Power supply	12 - 24 VDC ⇒ ± 10 %	100 - 240 VAC ~ ± 10 % 50 / 60 Hz
Power consumption	5 W	5 VA
Insulation resistance	Between external terminal and case: ≥ 100 MΩ (500 VDC ⇒ megger)	
Dielectric strength	Between external terminal and case: 2,000 VAC ~ 50 / 60 Hz for 1 min	
Noise immunity	± 2 kV square wave noise (pulse width: 1 μs) by the noise simulator	
Vibration	0.75 mm double amplitude at frequency of 10 to 55 Hz (for 1 min) in each X, Y, Z direction for 2 hours	
Vibration (malfunction)	0.5 mm double amplitude at frequency of 10 to 55 Hz (for 1 min) in each X, Y, Z direction for 10 min	
Shock	300 m/s <sup>2</sup> (≈ 30 G) in each X, Y, Z direction for 3 times	
Shock (malfunction)	100 m/s <sup>2</sup> (≈ 10 G) in each X, Y, Z direction for 3 times	
Relay life cycle	Mechanical: ≥ 20,000,000 operations Electrical: ≥ 100,000 operations (250 VAC ~ 3A resistive load)	
Ambient temp.	-10 to 50 °C, storage: -20 to 60 °C (freezing or condensation)	
Ambient humi.	35 to 85 %RH, storage: 35 to 85 %RH (freezing or condensation)	
Insulation type	Symbol:  double or reinforced insulation (dielectric strength between the measurement input part and the power part: 1 kV)	

## Communication Interface

### ■ RS485

Comm. protocol	Modbus RTU
Application standard	Compliance with EIA RS485
Max. connection	31 units (address: 01 to 99)
Comm. synchronous method	Asynchronous
Comm. method	2-wire half duplex
Comm. distance	≤ 800 m
Comm. speed	1,200 / 1,400 / 4,800 / 9,600 / 19,200 / 38,400 bps
Start bit	1-bit (fixed)
Data bit	8-bit (fixed)
Parity bit	None, Even, Odd
Stop bit	1-bit, 2-bit
EEPROM life cycle	≈ 1,000,000 operations (Erase / Write)

## Mode Setting

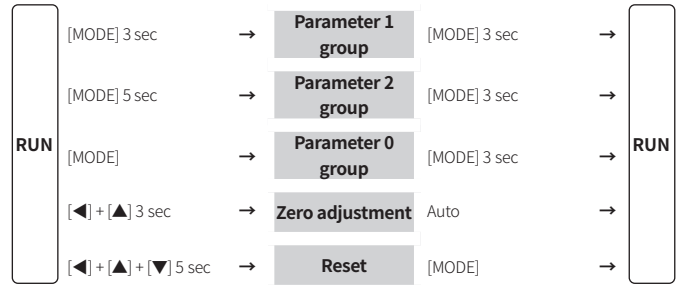

## Parameter Setting

- Some parameters are activated / deactivated depending on the model or setting of other parameters. Refer to the description of each parameter.
- If any key is not entered for 60 sec in each parameter, it returns to RUN mode.
- After returning to RUN mode, press the [MODE] key within 2 sec, it returns to previous parameter.
- [MODE] key: Saves current setting value and moves to the next parameter.
- [◀] key: Checks fixed value / Changes setting digits.
- [▲], [▼] key: Changes setting values.

### ■ Parameter 1 group

Parameter	Mark	Defaults	Setting range	Display condition
1-1 Input range	<i>i n r</i>	5 0 0 0 5 R	[DC voltage model], [AC voltage model] • Refer to Input Range and Display Range	-
1-2 Display method	<i>d i s p</i>	5 t n d	STND: standard, SCAL: scale, FREQ: frequency <sup>(1)</sup>	-
1-3 Measurement method	<i>i n t</i>	t r n s	[AC voltage model], [AC current model] T.RMS: True RMS, A.RMS: Average RMS, AVG • True RMS = $\sqrt{\frac{A_1^2 + A_2^2 + \dots + A_n^2}{n}}$ • Average RMS = $\frac{A_1 + A_2 + \dots + A_n}{n}$ × Waveform rate (n = number of display values per cycle, A = display value)	1-2 Display method: STND, SCAL
1-4 Max. display value (fixed)	<i>5 t n d</i>	5 0 0 0 5 0 0 0	[DC voltage model], [AC voltage model] Max. value of display range [DC current model], [AC current model] Max. value of display range	-
1-5 High-limit display value gradient correction	<i>i n b h</i>	1 0 0 0	0.100 to 5.000 %	1-2 Display method: STND
1-6 Low-limit display value deviation correction	<i>i n b l</i>	0 0	-99 to 99	-
1-7 Decimal point position	<i>d o t</i>	0 0 0 0 0 0	[DC voltage model], [AC voltage model] 0, 0.0, 0.00, 0.000 [DC current model], [AC current model] 0, 0.0, 0.00, 0.000	1-2 Display method: SCAL & * 1-7 Decimal point position: 0.0, 0.00, 0.000
1-8 High-limit scale	<i>H - 5 C</i>	-	Display value against max. measurement input*	-
1-9 Low-limit scale	<i>L - 5 C</i>	-	Display value against min. measurement input*	-
1-10 High-limit display value gradient correction	<i>i n b h</i>	1 0 0 0	0.100 to 5.000 %	-
1-11 Low-limit display value deviation correction <sup>(2)</sup>	<i>i n b l</i>	0 0	-99 to 99	-
1-12 Decimal point position <sup>(3)</sup>	<i>d o t</i>	0 0 0 0 0 0	[AC voltage model] 0, 0.0, 0.00, 0.000 [AC current model] 0, 0.0, 0.00, 0.000	1-2 Display method: FREQ
1-13 High-limit display value gradient correction	<i>i n b h</i>	1 0 0 0	0.100 to 9.999	-
1-14 Exponent of INB	<i>i n b E</i>	1 0 - 0	10-0: 10 <sup>0</sup> , 10-1: 10 <sup>-1</sup> , 10-2: 10 <sup>-2</sup> , 10 1: 10 <sup>1</sup>	-

01) Displays at AC voltage or AC current model only.

02) Low-limit display value deviation correction range is within -99 to 99 for D<sup>0</sup>, D<sup>1</sup> digit regardless of decimal point position.

03) Display range is variable according to decimal point position.

Dot	Display range	Frequency measurement range
0	-1999 to 9999	1 to 9999 Hz
0.0	-199.9 to 999.9	0.1 to 999.9 Hz
0.00	-19.99 to 99.99	0.10 to 99.99 Hz
0.000	-1.999 to 9.999	0.100 to 9.999 Hz

## Parameter 2 group

Parameter	Mark	Defaults	Setting range	Display condition
2-1 Output operation mode	oU t t	oFF	[Except indicator model] OFF, L.ST, H.ST, LH.ST, HH.ST, LL.ST, LD.ST • Refer to Output Operation Mode	-
2-2 Hysteresis	HYS	001	[Except indicator model] Within 10 % of max. display range, digit	2-1 Output operation mode: except OFF
2-3 Startup compensation time	StRt	000	[Except indicator model] 0.0 to 99.9 sec	-
2-4 Peak monitoring delay time	PEEt	005	00 to 30 sec	-
2-5 Display cycle	d1St	025	0.1 to 5.0 sec	-
2-6 Keys for zero adjustment	zEr0	no	NO, YES • YES: Press the [◀] + [▲] keys for 3 sec to adjust zero.	-
2-7 External input terminal	ExtIn	Hold	[Except indicator model] HOLD, ZERO • If the external input terminal is short-circuited for 50 ms or more, it operates with the set function.	-
2-8 High-limit value of transmission output	F5-H	5000	[DC voltage & Transmission (DC 4 - 20 mA) output model], [AC voltage & Transmission (DC 4 - 20 mA) output model] Max. value of display range	-
		5000	[DC current & Transmission (DC 4 - 20 mA) output model], [AC current & Transmission (DC 4 - 20 mA) output model] Max. value of display range	
2-9 Low-limit value of transmission output	F5-L	0000	[DC voltage & Transmission (DC 4 - 20 mA) output model], [AC voltage & Transmission (DC 4 - 20 mA) output model] Min. value of display range	-
		0000	[DC current & Transmission (DC 4 - 20 mA) output model], [AC current & Transmission (DC 4 - 20 mA) output model] Min. value of display range	
2-10 Comm. Address	Adr5	01	[RS485 Comm. output model] 01 to 99	-
2-11 Comm. speed	bP5	9600	[RS485 Comm. output model] 38.4k, 19.2k, 9600, 4800, 2400, 1200 bps	-
2-12 Parity bit	PrEtY	none	[RS485 Comm. output model] NONE, EVEN, ODD	-
2-13 Stop bit	StP	2	[RS485 Comm. output model] 2, 1 bit	-
2-14 Response waiting time	rStt	5	[RS485 Comm. output model] 5 to 99 sec	-
2-15 Lock	L0C	oFF	OFF: unlock, LOC1: lock parameter 1, LOC2: lock parameter 1, 2, LOC3: lock parameter 0, 1 and 2	-

## Parameter 0 group

Parameter	Mark	Defaults	Setting range	Display condition
0-1 Output high-limit output setting value	HSEt	5000	[DC voltage & Preset setting model] -5 to 110 % of display range [AC voltage & Preset setting model] 0 to 110 % of display range	2-1 Output operation mode: except OFF
		5000	[DC current & Preset setting model] -5 to 110 % of display range [AC current & Preset setting model] 0 to 110 % of display range	
0-2 Output low-limit output setting value	LSEt	0000	[DC voltage & Preset setting model] -5 to 110 % of display range [AC voltage & Preset setting model] 0 to 110 % of display range	2-1 Output operation mode: except OFF
		0000	[DC current & Preset setting model] -5 to 110 % of display range [AC current & Preset setting model] 0 to 110 % of display range	
0-3 Display max. peak value <sup>(1)</sup>	HPEt	00	[DC voltage], [AC voltage] Max. peak value in run mode	2-1 Output operation mode: except OFF & 2-4 Peak monitoring delay time: except 00
		0000	[DC current], [AC current] Max. peak value in run mode	
0-4 Display min. peak value <sup>(1)</sup>	LPEt	00	[DC voltage], [AC voltage] Min. peak value in run mode	2-1 Output operation mode: except OFF & 2-4 Peak monitoring delay time: except 00
		0000	[DC current], [AC current] Min. peak value in run mode	

(1) Reset: Press any one of [◀], [▼], [▲] keys.

## Input Range and Display Range

When the max. input value is over the 100 %, it may result in input terminal damage.

### DC voltage model

Input range	Display range		Input impedance
	Display method: STND (fixed)	Display method: SCAL <sup>(2)</sup>	
0 - 500 VDC≡	0.0 to 500.0	500u	4.33348 MΩ
0 - 100 VDC≡	0.0 to 100.0	100u	4.33348 MΩ
0 - 50 VDC≡	0.0 to 50.00	50u	433.48 kΩ
		0.0 -1999 to 9999	433.48 kΩ
0 - 10 VDC≡	0.0 to 10.00	10u	43.48 kΩ
		0.0 -199.9 to 999.9	43.48 kΩ
0 - 5 VDC≡	0.00 to 5.000	5u	43.48 kΩ
0 - 1 VDC≡	0.000 to 1.000	1u	2.28 kΩ
0 - 250 mVDC≡	0.0 to 250.0	025u	2.28 kΩ
0 - 50 mVDC≡	0.0 to 50.00	50u	2.28 kΩ

(1) Connect to the input terminals whose 30 % to 100 % of the input range includes the max. value of the input range to measure.  
When the max. input value is under the 30 % of the input terminal range, display accuracy is degraded.

### DC current model

Input range	Display range		Input impedance
	Display method: STND (fixed)	Display method: SCAL <sup>(2)</sup>	
0 - 5 A	0.00 to 5.000	5A	0.022 Ω
0 - 2 A	0.00 to 2.000	2A	0.022 Ω
0 - 500 mA	0.0 to 500.0	05A	0.222 Ω
		0.0 -1999 to 9999	0.222 Ω
0 - 200 mA	0.0 to 200.0	02A	2.222 Ω
		0.0 -199.9 to 999.9	2.222 Ω
0 - 50 mA	0.00 to 50.00	50mA	22.222 Ω
4 - 20 mA	4.00 to 20.00	4-20	22.222 Ω
0 - 5 mA	0.000 to 5.000	5mA	22.222 Ω
0 - 2 mA	0.000 to 2.000	2mA	22.222 Ω

(1) Connect to the input terminals whose 30 % to 100 % of the input range includes the max. value of the input range to measure.  
When the max. input value is under the 30 % of the input terminal range, display accuracy is degraded.

### AC voltage model

Input range	Display range		Input impedance
	Display method: STND (fixed)	Display method: SCAL <sup>(2)</sup>	
0 - 500 VAC~	0.0 to 500.0	500u	5.01092 MΩ
0 - 250 VAC~	0.0 to 250.0	250u	5.01092 MΩ
0 - 110 VAC~ <sup>(2)</sup>	0.0 to 440.0	110P	1.11092 MΩ
		0.0 -1999 to 9999	1.11092 MΩ
0 - 50 VAC~	0.00 to 50.00	50u	200.92 kΩ
0 - 20 VAC~	0.00 to 20.00	20u	200.92 kΩ
0 - 10 VAC~	0.00 to 10.00	10u	20.92 kΩ
0 - 2 VAC~	0.000 to 2.000	2u	20.92 kΩ
0 - 1 VAC~	0.000 to 1.000	1u	20.92 kΩ

(1) Connect to the input terminals whose 30 % to 100 % of the input range includes the max. value of the input range to measure.  
When the max. input value is under the 30 % of the input terminal range, display accuracy is degraded.

(2) In case of 0 to 110 VAC~ of AC voltage range and using PT (potential transformer) for 440 VAC~ / 110 VAC~, if 110 VAC~ is input, and the unit displays 440 VAC~ automatically by preset scale value for PT user's convenient.

### AC current model

Input range	Display range		Input impedance
	Display method: STND (fixed)	Display method: SCAL <sup>(2)</sup>	
0 - 5 A	0.00 to 5.000	5A	0.02 Ω
0 - 2.5 A	0.00 to 2.500	2.5A	0.02 Ω
0 - 1 A	0.00 to 1.000	1A	0.102 Ω
		0.0 -1999 to 9999	0.102 Ω
0 - 500 mA	0.0 to 500.0	05A	0.202 Ω
0 - 250 mA	0.0 to 250.0	025A	0.202 Ω
		0.0 -1999 to 9999	0.202 Ω
0 - 100 mA	0.0 to 100.0	01A	1.022 Ω
0 - 50 mA	0.00 to 50.00	50mA	1.022 Ω

(1) Connect to the input terminals whose 30 % to 100 % of the input range includes the max. value of the input range to measure.  
When the max. input value is under the 30 % of the input terminal range, display accuracy is degraded.

## Output Operation Mode

- H.SET or L.SET is displayed according to the output operation mode setting. In case of output operation mode as OFF, H.SET and L.SET are not displayed.
- When changing output operation mode, high-limit / low-limit output setting value, hysteresis are reset.

MODE	Output operation	Preset output		
		LO ON	HI ON	GO ON
		ON OFF		
$\alpha FF$		No output		
$L.5t$		$L.SET \geq$ Display value	-	$L.SET <$ Display value
$H.5t$		-	$H.SET \leq$ Display value	$H.SET >$ Display value
$L.H.5t$		$L.SET \geq$ Display value	$H.SET \leq$ Display value	$L.SET <$ Display value < $H.SET$
$HH.5t$		$L.SET \leq$ Display value	$H.SET \leq$ Display value	$L.SET >$ Display value
$L.L.5t$		$L.SET \geq$ Display value	$H.SET \geq$ Display value	$H.SET <$ Display value
$L.d.5t$		Second $L.SET$ $\geq$ Display value	-	$L.SET <$ Display value

## Reset

01. Press the [◀] + [▲] + [▼] keys for over 5 sec. in run mode, INIT flashes for 0.5 sec.
02. Press the direction keys to flash NO for 0.5 sec in turn.
03. Change the setting value as YES by pressing the direction keys.
04. Press the [MODE] key to reset all parameter values as default and to return to run mode.

## Error

Error display is released automatically when it is in the measured and display range.

Display	Description	Troubleshooting
HHHH	Flashes when measurement input is exceeded the max. allowable input (110 %)	Disconnect power supply and check the cables.
LLLL <sup>01)</sup>	Flashes when measurement input is exceeded the min. allowable input (-10 %)	
d - HH	Turns ON when display input is exceeded high-limit scale setting value or max. display range (9999)	Reset within the display range.
d - LL	Turns ON when display input is exceeded low-limit scale setting value or min. display range (-1999)	
F - HH	Turns ON when input frequency is exceeded the max. display value of measured range	-
$\alpha \cup E r$	Flashes twice when it exceeds zero range ( $\pm 99$ ) and returns to run mode	Reset within the zero range.

01) Displays at DC input model only.

## Time Chart

### Low speed serial output (negative logic)

It outputs current display value as Low-frequency (50 Hz) type.

[Clock frequency: 50 Hz]

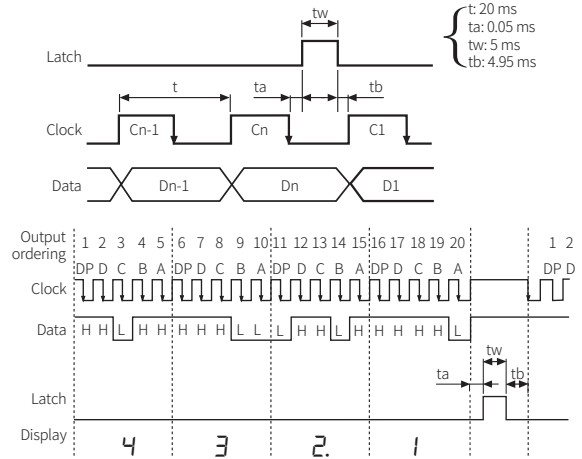

### BCD Dynamic output (negative logic)

It outputs display value as BCD code.

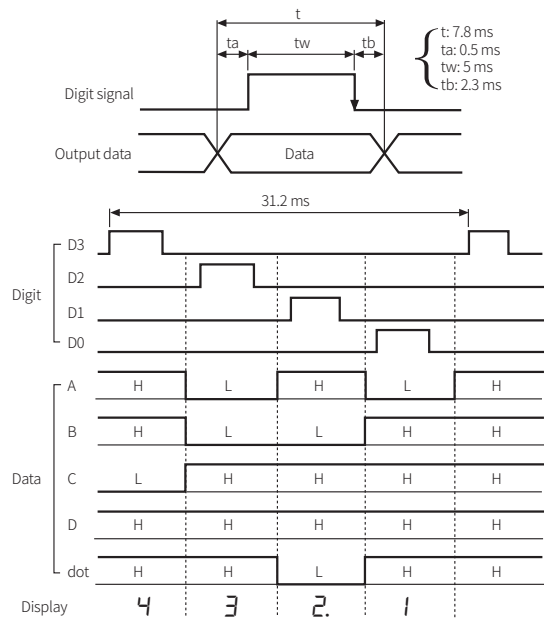

## Function Description

### ■ Display method: frequency

It measures input signal frequency when it is AC input. In order to measure frequency normally, input signal, over 10 % F.S. of the rated input range, should be supplied. Otherwise, it may not be measured normally. The measurement range differs depending on the decimal point position. It is available to adjust the high-limit display value gradient correction and exponent of INB at parameter setting.

- Accuracy of frequency measurement: below 1 kHz, F.S.  $\pm 0.1\%$  rdg  $\pm 2$ -digit, from 1 k to 10 kHz, F.S.  $\pm 0.3\%$  rdg  $\pm 2$ -digit

### ■ High-limit display value gradient correction

This function is to correct a gradient of High / Low-limit scale value. And also can be used as correction function of high-limit scale value. Adjustment range is setting value and multiply current gradient.

- E.g.: To display 3.000 when 200 mVDC for input range 0-1 VDC

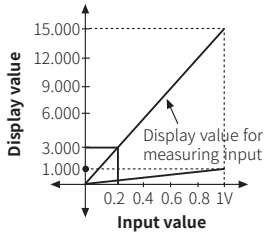

H-SC	L-SC	INB.H	Result
-	0.000	1.000	Disable
7.500	0.000	2.000	200 mVDC= = 3.000
5.000	0.000	3.000	
3.750	0.000	4.000	
3.000	0.000	5.000	

- Select input range = 1V, decimal point position = 0.000 for measurement input in Parameter 1.
- It has to be 15.000 at high-limit scale for 1 VDC in order to display 3.000 for 200 mVDC.
- In this case, please set as high-limit display value gradient correction  $\times$  high-limit scale = 15.000.

### ■ High / Low-limit scale value

This function is to display setting of particular High / Low-limit value in order to display High / Low-limit value of measured input. If measured inputs are a and b and particular values are A and B, it will display a = A, b = B as below graphs.

- When changing input range, it is changed automatically as factory default display range of the input range.

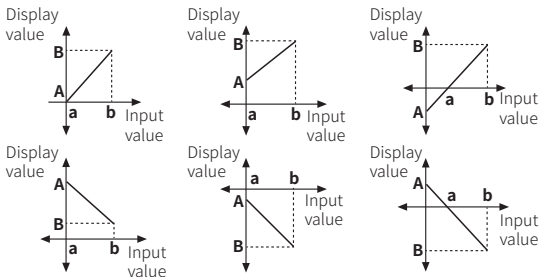

### ■ Zero adjustment

It adjusts the display value of the optional configured input value as zero by force. Zero point error can be adjusted with 3 ways as below.

- Direct input correction value at Low-limit display value deviation correction parameter.
- Set the keys for zero adjustment parameter to YES and press the [◀] + [▲] keys for 3 sec in RUN mode.
- Set the external input terminal parameter to ZERO and short the Hold / Zero terminal for over 50 ms.

### ■ Error correction

It corrects display value error of measured input.

$$\text{Display value} = (\text{Measured value} \times \text{High-limit display value gradient correction}) + \text{Low-limit display value deviation correction}$$

- E.g.: When the Input range 0 to 500 VDC and the display range is 0 to 500.0

If the low-limit display value is 1.2 to 0 VDC input, set -12 as deviation correction value to display 0.0 by adjusting offset of the low-limit display value. The display value to 500 VDC measured input varies by adjusting the offset of low-limit display value. If this display value is 501.0, calculate  $500.0 / 501.0$  (desired display value / the display value), and set the 0.998 correction value as the High-limit display value gradient correction parameter to display 500.0 by adjusting gradient of high-limit value.

### ■ Startup compensation time

This time function limits the operation of an output until the measured input (overvoltage or inrush current) is stable at moment of power on. All outputs are OFF during startup compensation time setting after power is applied.

### ■ Display cycle

In some applications the measured input may fluctuate which in turn causes the display to fluctuate. By adjusting the display cycle delay function time the operator can adjust the display time. For example, if the operator sets the display cycle time to 4 sec, the display value displayed will be the average input value over 4 sec and also will show any changes if any every 4 sec.

### ■ Max. / Min. peak value

It monitors max./min. peak value based on the current displays value and then displays the data at the parameters. When pressing any one of front keys at the parameters, the monitored data is initialized. Set the delay time at peak monitoring delay time parameter in order to prevent malfunction caused by initial overcurrent or overvoltage, when monitoring the peak value.

### ■ Transmission (DC 4 - 20 mA) output scale adjustment

It sets transmission output for the display value at the output current DC 4 - 20 mA. It sets display value for 4 mA at low-limit value of transmission output and 20 mA at high-limit value of transmission output.

- The range between high-limit value of transmission output and low-limit value of transmission output should be 10 %.
- When min. set interval under 10 % F.S., it changed as over 10 % F.S. automatically.
- Preset display value is fixed to output as 4 mA at under low-limit value of transmission output and 20 mA at over high-limit value of transmission output.

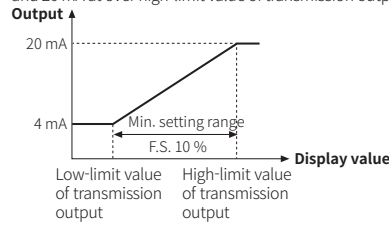

### Segment Table

The segments displayed on the product indicate the following meanings. It may differ depending on the product.

7 segment				11 segment				12 segment				16 segment			
0	0	l	l	0	0	l	l	0	0	l	l	0	0	l	l
1	1	l	J	1	1	l	J	1	1	l	J	1	1	l	J
2	2	l	K	2	2	l	K	2	2	l	K	2	2	l	K
3	3	l	L	3	3	l	L	3	3	l	L	3	3	l	L
4	4	l	M	4	4	l	M	4	4	l	M	4	4	l	M
5	5	l	N	5	5	l	N	5	5	l	N	5	5	l	N
6	6	l	O	6	6	l	O	6	6	l	O	6	6	l	O
7	7	l	P	7	7	l	P	7	7	l	P	7	7	l	P
8	8	l	Q	8	8	l	Q	8	8	l	Q	8	8	l	Q
9	9	l	R	9	9	l	R	9	9	l	R	9	9	l	R
A	A	l	S	A	A	l	S	A	A	l	S	A	A	l	S
b	B	l	T	b	B	l	T	b	B	l	T	b	B	l	T
c	C	l	U	c	C	l	U	c	C	l	U	c	C	l	U
d	D	l	V	d	D	l	V	d	D	l	V	d	D	l	V
E	E	l	W	E	E	l	W	E	E	l	W	E	E	l	W
F	F	l	X	F	F	l	X	F	F	l	X	F	F	l	X
G	G	l	Y	G	G	l	Y	G	G	l	Y	G	G	l	Y
H	H	l	Z	H	H	l	Z	H	H	l	Z	H	H	l	Z